

Bariatric Bed

BAR750



DEALER: This manual **MUST** be given to the user of the bed.

USER: **BEFORE** using this bed, read this manual and save for future reference.

For more information regarding
Invacare products, parts, and services,
please visit www.invacare.com



Yes, you can:

⚠ WARNING

DO NOT OPERATE THIS EQUIPMENT WITHOUT FIRST READING AND UNDERSTANDING THIS MANUAL. IF YOU ARE UNABLE TO UNDERSTAND THE WARNINGS, CAUTIONS, AND INSTRUCTIONS, CONTACT A HEALTHCARE PROFESSIONAL, DEALER OR TECHNICAL PERSONNEL IF APPLICABLE BEFORE ATTEMPTING TO USE THIS EQUIPMENT - OTHERWISE INJURY OR DAMAGE MAY RESULT.

THE INITIAL SET UP OF THIS BED MUST BE PERFORMED BY A QUALIFIED TECHNICIAN.

PROCEDURES OTHER THAN THOSE DESCRIBED IN THIS MANUAL MUST BE PERFORMED BY A QUALIFIED TECHNICIAN.

FOR DEALERS ONLY - SET-UP AND ASSEMBLY INSTRUCTIONS ARE IN THE REAR OF THIS MANUAL. THESE PROCEDURES MUST BE PERFORMED BY A QUALIFIED TECHNICIAN ONLY.

NOTE: Updated versions of this manual are available on www.invacare.com.

TABLE OF CONTENTS

SPECIAL NOTES	7
TYPICAL PRODUCT PARAMETERS	8
LABEL LOCATIONS	9
SECTION 1—GENERAL GUIDELINES	10
Important Safety Instructions	10
Operating Information.....	11
Replacement Parts/Accessories	12
Electrical	13
Repair or Service Information.....	13
Grounding Instructions.....	14
Radio Frequency Interference	14
Weight Limitations.....	14
SECTION 2—OPERATION	15
Operating Bariatric Bed	15
Raising and Lowering the Entire Bed.....	15
Raising and Lowering the Head and Foot Sections.....	16
Upright Back Position (Fowler)	16
Steering the Bed.....	16
Locking the Casters.....	16
Unlocking the Casters	17
Adjusting Bed Rail.....	17
SECTION 3—MAINTENANCE	19
Maintenance and Cleaning Checklist.....	19
Cleaning and Disinfecting Bed.....	19
Mechanical Inspection and Maintenance.....	19
Electrical Inspection and Maintenance	19
Pass/Fail	20
ASSEMBLY, MAINTENANCE AND ADJUSTMENT SECTIONS - FOR DEALERS ONLY	21
Overview of Procedures.....	21
Receiving	21
Set-Up.....	21
Inspecting the Bed.....	21
Storing	21

TABLE OF CONTENTS

SECTION 4—PACKAGING, HANDLING AND SET-UP	22
Receiving.....	22
Set-Up	22
Assembling the Bed	22
Adjusting the Bed.....	25
Adjusting Length 25	
Adjusting Width 25	
Inspecting the Bed	26
Storing the Beds.....	26
SECTION 5—MAINTENANCE	27
Maintenance Checklist.....	27
Mechanical Inspection and Maintenance.....	27
Electrical Inspection and Maintenance	27
Pass/Fail	27
SECTION 6—TROUBLESHOOTING	28
Troubleshooting: Electrical.....	28
Troubleshooting: Mechanical	29
LIMITED WARRANTY	31
Product Distributed by Invacare 32	

REGISTER YOUR PRODUCT

The benefits of registering:

1. Safeguard your investment.
2. Ensure long term maintenance and servicing of your purchase.
3. Receive updates with product information, maintenance tips, and industry news.
4. Invacare can contact you or your provider, if servicing is needed on your product.
5. It will enable Invacare to improve product designs based on your input and needs.

Register ONLINE at www.invacare.com

- or -

Complete and mail the form on the next page

Any registration information you submit will be used by Invacare Corporation only, and protected as required by applicable laws and regulations.



PRODUCT REGISTRATION FORM

Register **ONLINE** at www.invacare.com - or -
Complete and mail this form

Name _____

Address _____

City _____ State/Province _____

Zip/Postal Code _____

Email _____ Phone No. _____

Fold
here

Invacare Model No. _____ Serial No. _____

Purchased From _____ Date of Purchase: _____

1. Method of purchase: (check all that apply)

Medicare Insurance Medicaid Other _____

2. This product was purchased for use by: (check one)

Self Parent Spouse Other

3. Product was purchased for use at:

Home Facility Other

4. I purchased an Invacare product because:

Price Features (list features) _____

5. Who referred you to Invacare products? (check all that apply)

Doctor Therapist Friend Relative Dealer/Provider Other _____

Advertisement (circle one): TV, Radio, Magazine, Newspaper No Referral _____

6. What additional features, if any, would you like to see on this product?

Fold
here

7. Would you like information sent to you about Invacare products that may be available for a particular medical condition? Yes No

If yes, please list any condition(s) here and we will send you information by email and/or mail about any available Invacare products that may help treat, care for or manage such condition(s):

8. Would you like to receive updated information via email or regular mail about the Invacare home medical products sold by Invacare's dealers? Yes No

9. What would you like to see on the Invacare website?

10. Would you like to be part of future online surveys for Invacare products? Yes No

11. User's Year of birth: _____

If at any time you wish not to receive future mailings from us, please contact us at Invacare Corporation, CRM Department, 39400 Taylor Parkway, Elyria, OH 44035, or fax to 877-619-7996 and we will remove you from our mailing list.

To find more information about our products, visit www.invacare.com.

Cut Along Line



Fold
here

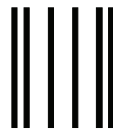

BUSINESS REPLY MAIL
FIRST-CLASS MAIL PERMIT NO. 196 ELYRIA OH

POSTAGE WILL BE PAID BY ADDRESSEE

NO POSTAGE
NECESSARY
IF MAILED
IN THE
UNITED STATES

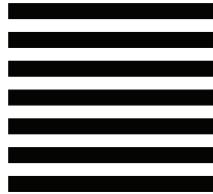

INVACARE CORPORATION
CRM DEPARTMENT
39400 TAYLOR PARKWAY
ELYRIA OH 44035-9836



Fold
here

Invacare Product Registration Form

Please Seal with
Tape Before Mailing

Cut Along Line



SPECIAL NOTES

Signal words are used in this manual and apply to hazards or unsafe practices which could result in personal injury or property damage. Refer to the table below for definitions of the signal words.

SIGNAL WORD	MEANING
DANGER	Danger indicates an imminently hazardous situation which, if not avoided, will result in death or serious injury.
WARNING	Warning indicates a potentially hazardous situation which, if not avoided, could result in death or serious injury.
CAUTION	Caution indicates a potentially hazardous situation which, if not avoided, may result in property damage.

NOTICE

THE INFORMATION CONTAINED IN THIS DOCUMENT IS SUBJECT TO CHANGE WITHOUT NOTICE.

Invacare products are specifically designed and manufactured for use in conjunction with Invacare accessories. Accessories designed by other manufacturers have not been tested by Invacare and are not recommended for use with Invacare products.

TYPICAL PRODUCT PARAMETERS

BAR 750 BARIATRIC BED	
MAXIMUM OVERALL WIDTH:	48 inches (121.9 cm)
WIDTH EXTENDER:	39 inches (99 cm) 42 inches (106.6 cm) 48 inches (121.9 cm)
MAXIMUM OVERALL LENGTH (WITH HEADBOARD AND FOOTBOARD):	88 inches (223.5 cm) ± 2 inches with 80 inch (203.2 cm) deck 96 inches (243.8 cm) ± 2 inches with 88 inch (223.5 sm) deck
CASTERS:	5 inches (12.7 cm)
BACK ANGLE:	5 - 60°
SHIPPING WEIGHT:	440 lbs (without trapeze)
WEIGHT LIMITATION:	750 lbs (Including accessories, mattress, occupant and any other objects positioned on the bed)

LABEL LOCATIONS

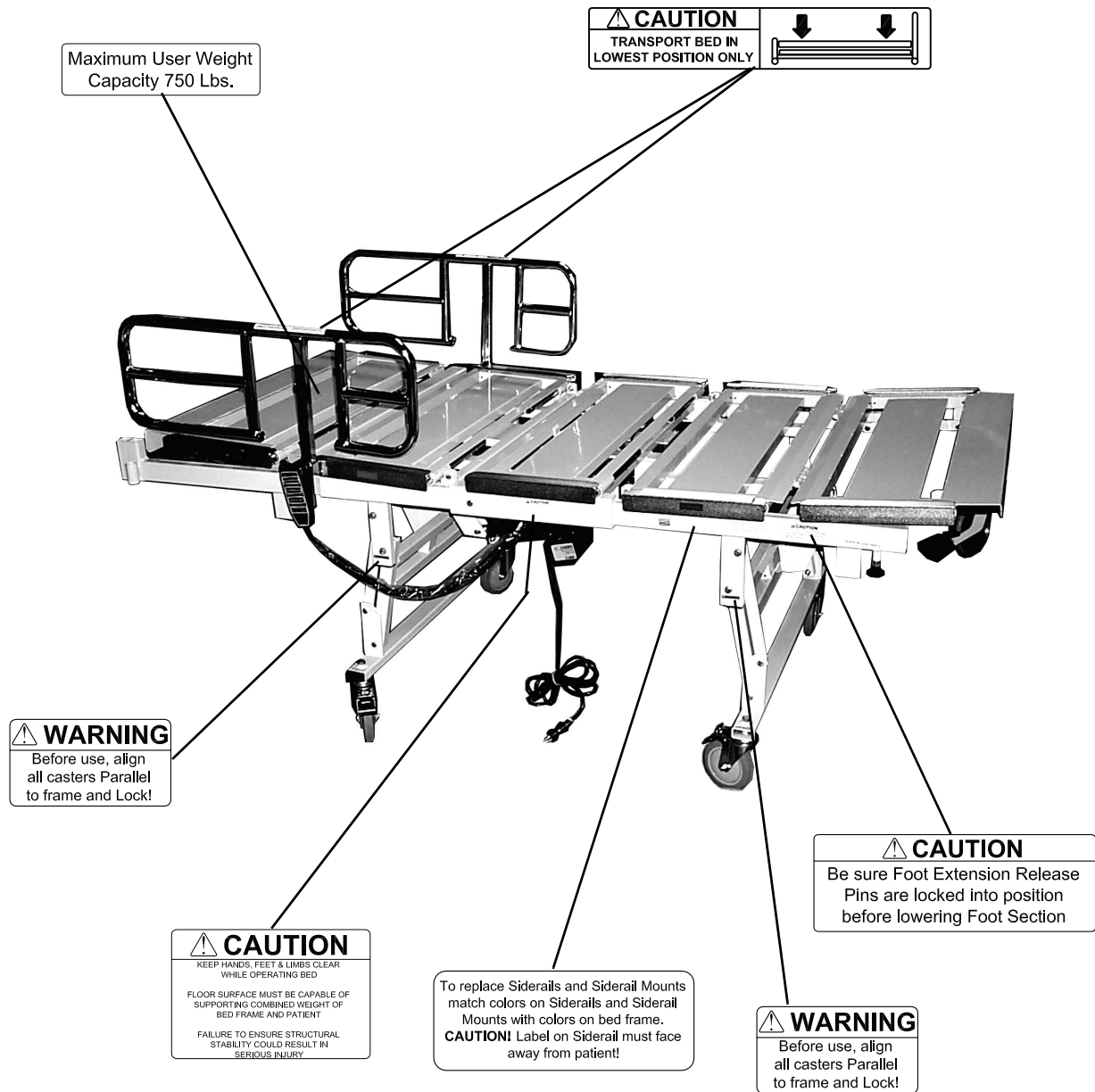

NOTE: The same labels are located on the other side of the bed.

SECTION I—GENERAL GUIDELINES

⚠ WARNING

SECTION I - GENERAL GUIDELINES contains important information for the safe operation and use of this product. **DO NOT** use this product or any available optional equipment without first completely reading and understanding these instructions and any additional instructional material such as **Owner's Manuals, Service Manuals or Instruction Sheets** supplied with this product or optional equipment. If you are unable to understand the **Warnings, Cautions or Instructions**, contact a healthcare professional, dealer or technical personnel before attempting to use this equipment - otherwise, injury or damage may occur.

Important Safety Instructions

When using the bed, basic precautions should always be followed, including the following:

Read all the instructions before using the bed.

DANGER - To reduce the risk of electric shock:

1. Always unplug the bed from the electrical outlet before cleaning.

WARNING - To reduce the risk of burns, fire, electric shock, or injury to persons:

1. Unplug from the outlet before servicing.
2. Close supervision is necessary when the bed is used by, or near children and/or disabled persons.
3. Use this bed only for its intended use as described in these instructions. **DO NOT** use attachments not recommended by the manufacturer.
4. **NEVER** operate this bed if it has a damaged cord or plug, if it is not working properly, if it has been dropped, damaged, or dropped into water. Return the bed to a service center for examination and repair.
5. Keep the cord away from heated surfaces.
6. **DO NOT** use outdoors.
7. Use masked or nasal type oxygen administering equipment only in conjunction with the manual/electric bed. The use of **ANY** other type of oxygen administering equipment can result in a fire hazard.
8. To disconnect pendant, **DO NOT** depress pendant buttons.
9. Risk of electric shock - Connect this bed to a properly grounded outlet only. Refer to **Grounding Instructions** on page 14.
10. Risk of injury to persons - **DO NOT** place video equipment such as televisions or computer monitors on bed.

SAVE THESE INSTRUCTIONS

Operating Information

Check all parts for shipping damage and test before using. In case of damage, DO NOT use. Contact a qualified technician for further instruction.

After any adjustments, repair or service and before use, make sure all attaching hardware is tightened securely.

Close supervision is necessary when the electric bed is used by or near children and physically challenged individuals.

DO NOT let any individual underneath the bed or in between the raised bed frame components at anytime.

When bed is not to be used for an extended period, unplug electric bed from the wall outlet.

Keep the product a minimum of 12 inches away from any direct heat source.

DO NOT unplug power cord from junction box.

If a liquid is spilled in or around the electric bed, unplug the electric bed before cleaning. Clean up the spill and allow the electric bed or the area around the electric bed to dry thoroughly before using the electric controls again.

The electric bed is not designed to be used as a patient transport. When transporting a patient, use an approved patient transport. Otherwise, injury or damage may result.

When operating/moving electric beds, ALWAYS ensure that the individual utilizing the bed is positioned properly within the confines of the bed. DO NOT let any extremities protrude over the side or between the bed rails when performing these functions.

After the electric bed has been assembled, ALWAYS test to make sure that all sections of the electric bed are properly and securely in place before using.

Make sure head and foot springs/sections are connected securely to the universal bed ends before use.

NEVER operate the unit if these cords are damaged.

If the unit is not working properly, call a qualified technician to examine the unit and repair it.

Keep all moving parts, including the main frame, mattress deck (head and foot springs/sections) and all drive shafts, free of obstruction (i.e. blankets/sheets, heating blankets/pads, tubing, wiring, etc. and other types of products using electric cords which may get tangled around the bed, bed rails or legs) during operation of the electric bed.

The electric bed is equipped with locking casters. When transferring into or out of the electric bed, ALWAYS lock the locking caster(s). Inspect the wheel locks for correct locking action before actual use. Even with casters properly locked, some flooring surfaces such as tile or wood, will allow the bed to move under some conditions. Use on surfaces such as these MUST be evaluated by the care provider.

Ensure that all four casters are locked and that the bed does not move before transferring. DO NOT transfer occupant if bed is not stable.

⚠ ENTRAPMENT WARNING

Proper patient assessment and monitoring, and proper maintenance and use of equipment is required to reduce the risk of entrapment. Variations in bed rail dimensions, and mattress thickness, size or density could increase the risk of entrapment. Visit the FDA website at <http://www.fda.gov> to learn about the risks of entrapment. Review “A Guide to Bed Safety”, published by the Hospital Bed Safety Workgroup, located at www.invacare.com. Use the link located under each bed rail product entry to access this bed safety guide.

Refer to the owners manuals for beds and rails for additional product and safety information.

After any adjustments, repair or service and before use, make sure all attaching hardware is tightened securely. Assist rails with dimensions different from the original equipment supplied or specified by the bed manufacturer may not be interchangeable and may result in entrapment or other injury.

Mattress MUST fit bed frame and assist rails snugly to reduce the risk of entrapment.

Replacement Parts/Accessories

Use masked or nasal type oxygen administering equipment only in conjunction with the electric bed. The use of any other type of oxygen administering equipment can result in a fire hazard.

When using nasal or masked type oxygen administering equipment, the oxygen or air tubing **MUST** be routed and secured properly to ensure that the tubing does not become entangled and/or severed during normal operation of electric bed.

ALWAYS test to make sure that the bed rails are properly and securely in place before using the electric bed.

Invacare recommends that the mattress be centered on the bed frame. Otherwise, individuals may become entangled between the bed rail and the bed frame.

Physically challenged individuals who cannot prevent themselves from rolling/climbing out of the electric bed may require alternative safe means of restraint.

The bed rails **DO NOT** fall under any weight limitations. Bed rails can be deformed or broken if excessive side pressure is exerted on the bed rails. These bed rails are used for the purpose of preventing an individual from inadvertently rolling out of bed. The bed rails are not intended nor may be used for restraint purposes. If an individual is capable of injuring himself/herself, a physician or a healthcare professional should be consulted for alternative means of safe restraint.

After raising/lowering the head/foot end of the electric bed, check the distance between the bottom of the bed rail and the mattress. If there is excessive distance between the bottom of the bed rail and the mattress in which individuals may become entangled, adjust the height of the bed rail (if applicable), or provide alternative means of patient protection.

DO NOT use the bed rails as push handles for moving the electric bed.

Replacement mattresses and bed rails with dimensions different from the original equipment supplied or specified by the bed frame manufacturer are not interchangeable. Variations in bed rail design, width and thickness or firmness of the mattress could cause/contribute to entrapment.

Invacare products are specifically designed and manufactured for use in conjunction with Invacare accessories. Accessories designed by other manufactures have not been tested by Invacare and are not recommended for use with Invacare products.

Electrical

⚠ DANGER

When using an extension cord, use only a three wire extension cord having at least 16 AWG (American Wire Gauge) wire and the same or higher electrical rating as the device being connected. Use of improper extension cord could result in a risk of fire and electric shock. Three prong to two prong adapters should not be used. Use of three prong adapters can result in improper grounding and present a shock hazard to the user.

NEVER operate if the unit has a damaged cord or plug. If it is not working properly, call a qualified technician for examination and repair.

Keep all electrical cords away from heated or hot surfaces.

Ensure all cables and cords are routed such that they will not become entangled or pinched. Otherwise damage or injury may result.

Repair or Service Information

DO NOT open assemblies such as the motors, pendant, junction boxes or gear boxes. No user serviceable parts are inside. Only qualified technicians are permitted to repair these parts. If unqualified individuals perform any work on these beds, the warranty is void.

Unplug the power cord from its power source before performing any maintenance on the electric bed. DO NOT unplug the power cord from the junction box. Damage to cord will result.

Before installing the connector into the junction box, be sure the side with the locking tab is facing downward - otherwise, injury or damage may occur.

Grounding Instructions

Electric beds are equipped with three-prong (grounding) plugs for protection against possible shock hazards. Where a two-prong wall receptacle is encountered, it is the personal responsibility and obligation of the customer to contact a qualified electrician and have the two-prong receptacle replaced with a properly grounded three-prong wall receptacle in accordance with the National Electrical Code. If you must use an extension cord, use only a three-wire extension cord having the same or higher electrical rating as the device being connected. DO NOT, under any circumstances, cut or remove the round grounding prong from any plug used with or for Invacare products. In addition, Invacare has placed RED warning tags on some equipment. DO NOT remove these tags.

For proper grounding, junction box MUST be securely connected to the bed with metal screws and the spacer provided or electrical shock could occur.

Radio Frequency Interference

Electronic equipment may be influenced by Radio Frequency Interference (RFI). Caution should be exercised with regard to the use of portable communications equipment in the area around such equipment. If RFI causes erratic behavior, unplug the electric bed immediately. Leave unplugged while transmission is in progress.

Weight Limitations

The total weight limit of the Bariatric Bed (including accessories, mattress, occupant and any other objects positioned on the bed) is 750 pounds (340 kg); 675 pounds (308 kg) patient weight.

NEVER permit more than one person on the electric bed at any time.

Body weight should be evenly distributed over the surface of the manual/electric bed. DO NOT lay, sit or lean in such a way that your entire body weight is placed only on raised head or foot sections of the bed. This includes when repositioning or transferring in or out of bed.

SECTION 2—OPERATION

Operating Bariatric Bed

⚠ WARNING

NEVER operate if the unit has a damaged cord or plug. If it is not working properly, call a qualified technician for examination and repair.

Keep all electrical cords away from heated or hot surfaces.

Ensure all cables and cords are routed such that they will not become entangled or pinched. Otherwise, damage or injury may result.

DO NOT place pendant under or between objects. This may unintentionally press the buttons and may cause injury or damage to occur.

The bariatric bed has three-function operation:

- Raise and lower head section
- Raise and lower foot section
- Raise and lower entire bed

Raising and Lowering the Entire Bed

NOTE: For this procedure, refer to FIGURE 2.1.

1. To raise the entire bed, press the Bed UP button.
2. To lower entire bed, press the Bed DOWN button.

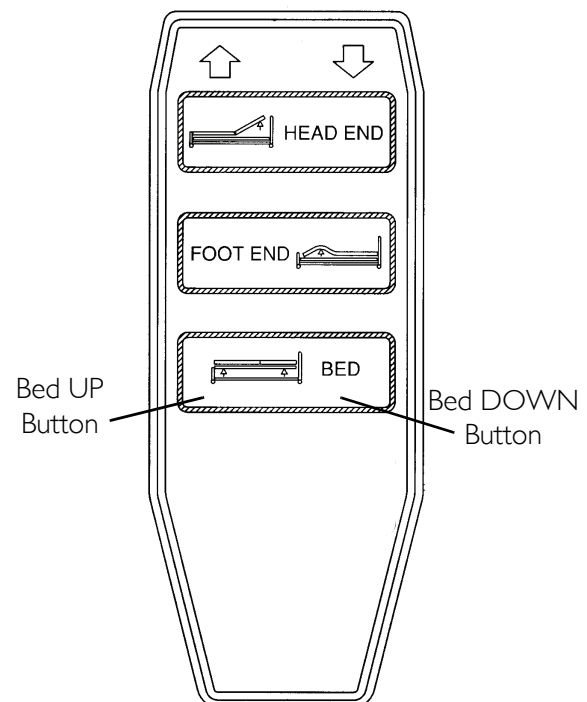

FIGURE 2.1 Raising and Lowering the Entire Bed

Raising and Lowering the Head and Foot Sections

NOTE: For this procedure, refer to FIGURE 2.2.

1. To raise the head of the bed, press the Head UP button.
2. To lower the head of the bed, press the Head DOWN button.
3. To raise the foot of the bed, press the Foot UP button.
4. To lower the foot of the bed, press the Foot DOWN button.

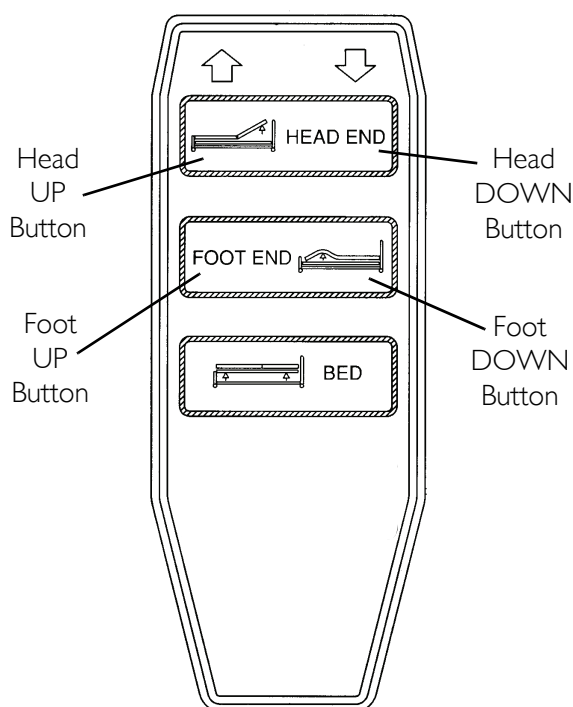

FIGURE 2.2 Raising and Lowering the Head and Foot Sections

Upright Back Position (Fowler)

⚠ WARNING

Before operating the backrest ALWAYS ensure that casters are locked. Otherwise an accident or injury may occur.

1. Raise the head section to Fowler position. Refer to Raising and Lowering the Head and Foot Sections.

NOTE: The backrest stops at any angle between five degrees (horizontal) position and an upright position of about 60 degrees.

Steering the Bed

NOTE: The bed can be steered in two modes, with the steering locked or with all four casters able to move independently. The two casters on the head end are the “steer” control type.

Locking the Casters

NOTE: For this procedure, refer to FIGURE 2.3 on page 17.

NOTE: The steering lock function allows you to easily steer the bed in a straight line.

1. Lower the bed to the lowest position. Refer to Operating Bariatric Bed on page 15.
2. At the head end of the bed, step down on the front of either caster pedal until it clicks.

NOTE: DO NOT lock the other steering caster.

3. Move the bed in a straight line about three feet backward or forward to lock.

NOTE: This action will keep the caster from swiveling and allow better forward and backward movement. The bed can now be moved with greater stability.

4. Push the bed from the foot end.

⚠ WARNING

Ensure that all four casters are locked and that the bed does not move before transferring. DO NOT transfer occupant if bed is not stable.

NOTE: The locking function holds the bed motionless when the bed is parked.

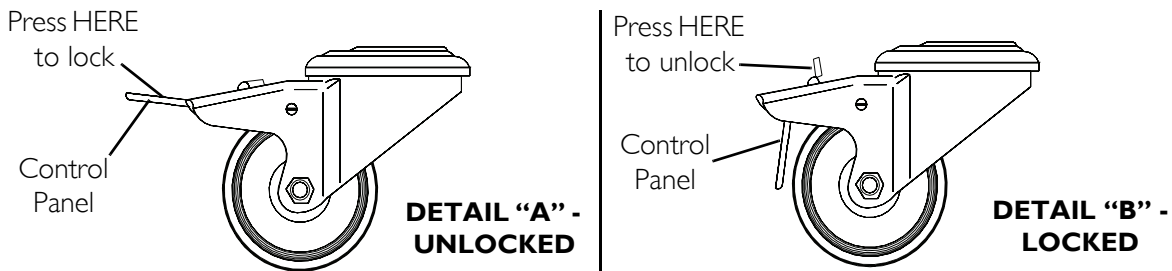

FIGURE 2.3 Locking the Casters

Unlocking the Casters

NOTE: To allow the bed to be rolled next to a stretcher, unlock all four casters.

1. Step down on the back of the control pedal on each caster.

Adjusting Bed Rail

⚠ WARNING

Make sure side rails are securely locked into position. Otherwise, an injury or accident may occur.

NOTE: For this procedure, refer to FIGURE 2.4 on page 18.

NOTE: Head end side rails are located on each side of the bed. Side rails have a three-position vertical adjustment.

1. To raise or lower bed rail, grab top section of rail with one hand while pulling the release knob with the other hand.
2. Pull bed rail up or down as required.
3. Allow the release knob to spring back into locked position.



FIGURE 2.4 Adjusting Bed Rail

SECTION 3—MAINTENANCE

CAUTION

To protect flooring, ensure bed end is completely drained and dry before placing on flooring. Otherwise, remaining dirty water may damage or stain flooring.

Avoid spraying water directly into the gear box ends. Otherwise, damage to the gear box may occur.

Maintenance and Cleaning Checklist

Invacare recommends the following maintenance and cleaning procedures be conducted between uses and at least once a year. This form is provided as a guide to help with documentation.

Cleaning and Disinfecting Bed

- Unplug the power cord of electric beds before performing maintenance.
- Wipe down with disinfectant. Allow to dry completely.

Mechanical Inspection and Maintenance

- Inspect all bed components for damage or excessive wear.
- Visually examine all welds for cracks.
- Inspect the head and foot spring sections for bending, warping or damage.
- Inspect pull tubes and mounting hardware for bending, damage or excessive wear.
- Inspect all bolts and rivets to ensure that they are securely tightened and functioning properly.
- Check sleep surfaces to ensure all links are intact.
- Check casters to ensure they lock and roll properly.
- Ensure casters are free of debris.

Electrical Inspection and Maintenance

- Inspect all electrical bed components for damage or excessive wear (i.e., cracked or broken housings, or worn components).
- Check pendant, power and motor cords for chafing, cuts or excessive wear.
- Make sure all plugs are fully attached and free of damage.

- Check all functions:
 - A. Head section raises and lowers properly.
 - B. Foot section raises and lowers properly.
 - C. Bed raises and lowers properly.

Pass/Fail

- PASS: Bed and all components have passed all of the preceding inspection criteria, and the bed is ready for placement into a client's home.
- FAIL: Bed, or any component, has failed any of the preceding inspection criteria. Tag the bed or component with a complete description of the failure(s) and have the bed serviced.

ASSEMBLY, MAINTENANCE AND ADJUSTMENT SECTIONS - FOR DEALERS ONLY

⚠ WARNING

The procedures in the following sections **MUST** be performed by a qualified technician.

Overview of Procedures

Receiving

Set-Up

- Assembling the Bed
- Adjusting the Bed

Inspecting the Bed

Storing

SECTION 4—PACKAGING, HANDLING AND SET-UP

Receiving

1. Count cartons before signing shipping papers.
2. Designate someone at the facility to receive and inspect all merchandise. Use the master order acknowledgment to check off items as they are received.
3. Compare the number of cartons shipped with the number of cartons actually received and note such on the consignee copy of the freight bill. Make sure to have the truck driver sign the copy acknowledging the count.
4. If shortage occurs, IMMEDIATELY contact Invacare at (800) 333-6900.

⚠ WARNING

DO NOT plug the power cord into a power source until assembly is complete. To do so could result in damage or personal injury.

DO NOT attempt to operate bed controls prior to completion of assembly. Otherwise, damage to bed components may occur.

Set-Up

Assembling the Bed

⚠ WARNING

DO NOT attempt to operate bed controls prior to completion of assembly as damage to bed components or personal injury may occur.

NOTE: For this procedure, refer to FIGURE 4.1 on page 24.

1. Remove packing bands from the bed. See Detail “A” of FIGURE 4.1.
2. Grasp castor mount on head-end section of bed.
3. Pull section up and flip it over until wheels touch the floor.
4. Grasp the back-rest of head-end section and rotate it until the section rests on the frame section already on floor. See Detail “B” of FIGURE 4.1.
5. Locate two clevis pins (one each side of bed) on backrest of head-end section which connect shipping brace to bed. See Detail “C” of FIGURE 4.1.
6. Remove the clevis pin from the bed and packing brace.
7. Repeat STEP 6 and 7 for the other side.

NOTE: Save clevis pins to assemble the bed.

8. Pull the head-end section from the shipping bracket.
9. Remove the clevis pin securing the shipping bracket to foot-end section from each side of the foot-end section. See Detail “D” of FIGURE 4.1.
10. Remove shipping bracket and two cardboard support blocks from foot-end bed section.
11. Unlock the casters on the foot-end section.
12. Place power supply cord and handset on top of the bed.
13. Carefully roll the foot-end section off the pallet.
14. Slide head-end section into foot-end section until side frame holes line up. See Detail “E” of FIGURE 4.1.

CAUTION

Keep power supply cord and handset clear of the gap between the two sections.

15. From the outside of the bed, insert a clevis pin into each side frame hole. Secure clevis pins using rue rings on inside of frame. See Detail “F” of FIGURE 4.1.
16. Secure the actuators to the frame section using two small clevis pins and two hairpin clips. See Detail “G” of FIGURE 4.1.
17. Using the hand control, raise the bed to its full height.
18. Remove lock-pin from support leg located under foot-end section.
19. Push support leg up and re-insert lock-pin. See Detail “H” of FIGURE 4.1.
20. Install the headboard posts in the inward most sockets provided at the head end with the board closest to the mattress.
21. Install the footboard posts in the inward most sockets provided at the foot end with the board closest to the mattress.

DETAIL "A"

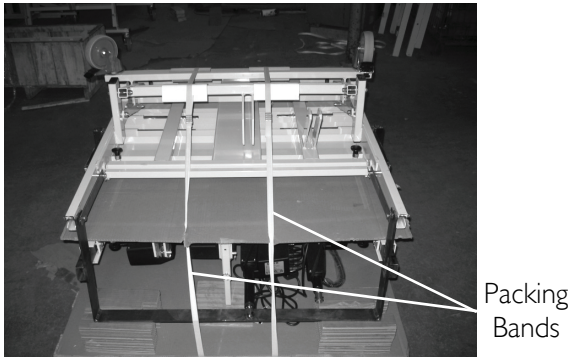

DETAIL "B"

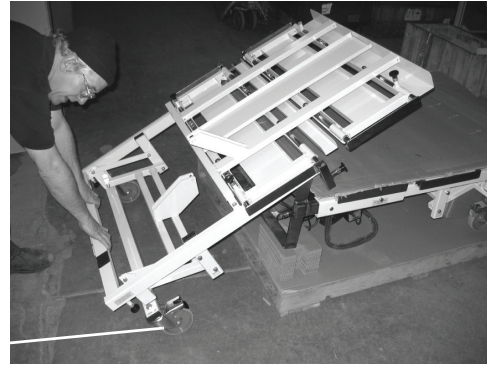

DETAIL "C"



DETAIL "D"



DETAIL "E"

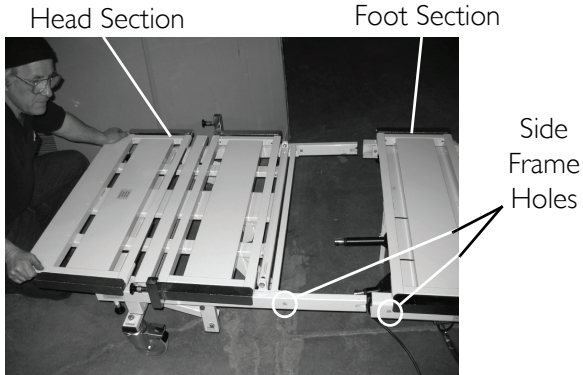

DETAIL "F"



DETAIL "G"

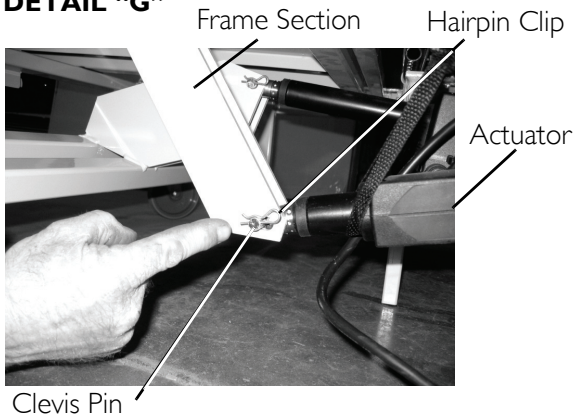

DETAIL "H"

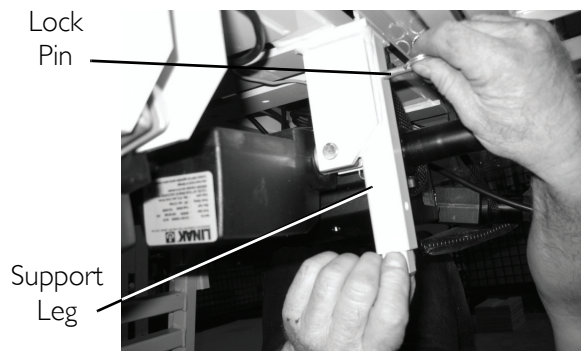

FIGURE 4.1 Assembling the Bed

Adjusting the Bed

Adjusting Length

NOTE: For this procedure, refer to FIGURE 4.2.

1. Pull down on the release knob located under the head section of the bed. See Detail "A" of FIGURE 4.2.
2. Pull the length extender out six inches.
3. Release the knob and push the extender in until the knob locks into place.

NOTE: An audible click will be heard.

4. If necessary, repeat STEPS 1 to 3 for the foot section. See Detail "B" of FIGURE 4.2.

DETAIL "A" - LENGTH EXTENDER

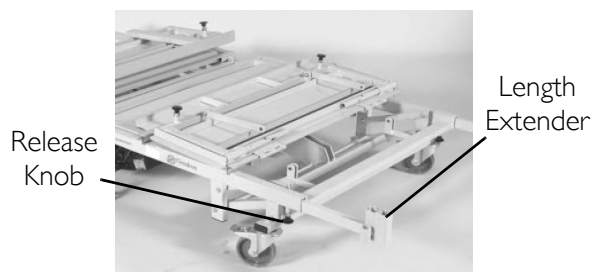

DETAIL "B" - HEAD AND FOOT SECTIONS

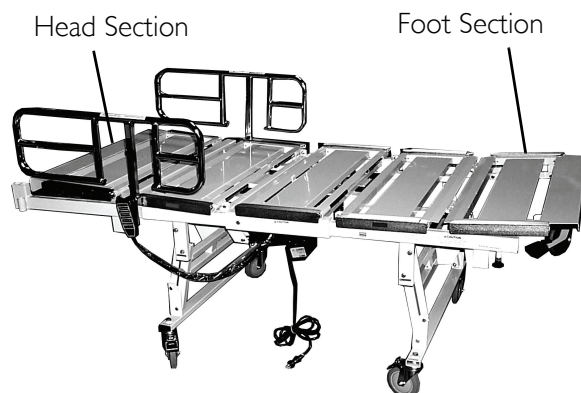

FIGURE 4.2 Adjusting the Bed

Adjusting Width

NOTE: For this procedure, refer to FIGURE 4.3.

1. Pull down on the release knob located under the side of the bed. See Detail "A" of FIGURE 4.3.
2. Slide the width extender to one of the three the desired widths.
3. Release the knob and push on the extender until the knob locks into place.

NOTE: An audible click will be heard.

4. Repeat STEPS 1 to 3 for the other four side sections on that side. See Detail "B" of FIGURE 4.2.
5. Repeat STPES 1 to 4 for the other side of the bed.

DETAIL "A" - WIDTH EXTENDER

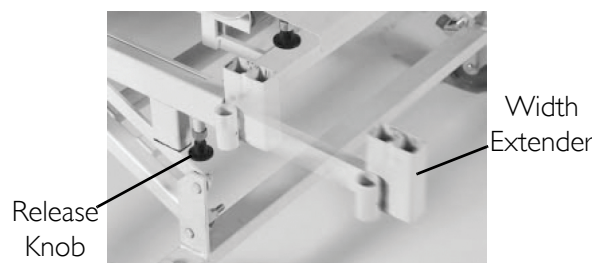

DETAIL "B" - SIDE SECTIONS

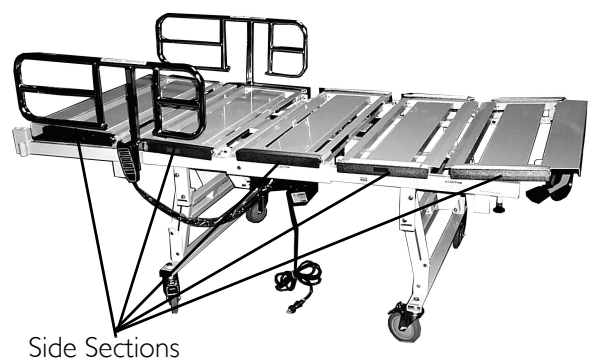

FIGURE 4.3 Adjusting Width

Inspecting the Bed

Examine each item carefully for scratches, nicks, dents or any other apparent damage.

NOTE: Check all parts for shipping damage. In case of shipping damage, DO NOT use. Contact Dealer/Carrier for further instruction.

1. Inspect the power supply cord and cables for cuts or damage to the cord and/or plug.
2. Inspect the junction box for any damage to the connectors.
3. Ensure that the motor plugs are plugged into the junction box and fit properly.
4. Do a careful inspection of the bed. Look underneath the bed to make sure there is nothing stored there. This area **MUST** be kept clear to avoid any interference with bed parts, which move during operation.
5. Lock the casters. Refer to Locking the Casters on page 16.
6. Plug the power cord into a 120 volt grounded socket with a capacity of at least 15 amperes. Using the handset, cycle the bed through all of its operations. (see pg 6) Make sure that everyone (including you) is clear of the bed during these operations. Ensure that:
 - A. All power bed operations work smoothly and stop in any desired position.
 - B. Bed height, angle of the leg lift and backrest can be adjusted properly.
7. Position the side rails, be sure they slide up and down properly
8. When you are satisfied that the bed is operating properly, instruct all personnel who may be involved in the bed operation.

Storing the Beds

CAUTION

DO NOT place other objects on top of the cartons.

If bed is not being assembled immediately, retain the cartons and packaging for storage until ready for assembly.

SECTION 5—MAINTENANCE

Maintenance Checklist

Invacare recommends the following maintenance procedures be conducted at least once every three years. This form is provided as a guide to help with documentation.

Mechanical Inspection and Maintenance

- Inspect all bed components for damage or excessive wear.
- Visually examine all welds for cracks.
- Inspect the head and foot spring sections for bending, warping or damage.
- Check drive shaft and drive shaft connections for bending, damage or excessive wear.
- Inspect pull tubes and mounting hardware for bending, damage or excessive wear.
- Inspect all bolts and rivets to ensure that they are securely tightened and functioning properly.
- Check casters to ensure they lock, if applicable, and roll properly.
- Ensure casters are free of debris.

Electrical Inspection and Maintenance

- Inspect all electrical bed components for damage or excessive wear (i.e., cracked or broken housings, or worn components).
- Check pendant, power and motor cords for chafing, cuts or excessive wear.
- Make sure all plugs are fully attached and free of damage.
- Check all functions (head, foot, and bed ends raise and lower properly).

Pass/Fail

- PASS:Bed and all components have passed all of the above inspection criteria and the bed is ready for placement into a client's home.
- FAIL:Bed, or any component, has failed any of the above inspection criteria. Tag the bed or component with a complete description of the failure(s) and have the bed serviced.

SECTION 6—TROUBLESHOOTING

⚠ WARNING

Read all general guidelines, warnings and cautions before performing any repair/maintenance on the bed. All repair and maintenance on the bed should be performed by a qualified technician.

Troubleshooting: Electrical

SYMPTOM	PROBABLE CAUSE	SOLUTIONS
Bed section does not move.	End of stroke reached.	Operate opposite button.
Bed functions do not operate.	No power to unit.	Ensure power cord is plugged into power source.
	Pendant not functioning.	Ensure Pendant correctly connected to junction box under the bed. Ensure Pendant cable is not entangled/pinched.
	Fuse or breaker blown.	Check fuse/breaker box.
	Motors are not functioning.	Call Invacare.
Green power on light does not illuminate.	Electrical power cord is not properly plugged into the control module.	Check the power cord for breaks.
Power cord is plugged in, but no functions operate.	Bad handset.	Handset needs to be replaced. Contact Invacare.
	Bad control module.	Control module needs to be replaced. Contact Invacare.
Bed Spring does not stop moving.	Pendant	Check for depressed/stuck buttons. If button is stuck, call dealer for repair.
One actuator does not work.	Bad control module.	ISOLATE THE PROBLEM: Interchange connections on control module so that problem actuator is plugged into an actuator connection on the control module that is working satisfactorily. If problem actuator now operates "OK", but actuator that was operating "OK" now has a problem, either the control module or handset is faulty. Replace as required.
	Bad handset.	
	Bad actuator motor.	
Actuator will not function properly. Or not at all.	Defective wiring.	Check wiring between control and actuator. Reverse wires.
	Defective actuator motor.	Replace actuator.
Battery will not charge.	Defective battery.	Replace battery.
Bed is not grounded.	Unit is not grounded between power cord and frame or between power cord and wall receptacle.	Check ground (GREEN) wire between frame and power cord.

Troubleshooting: Mechanical

SYMPTOM	PROBABLE CAUSE	SOLUTIONS
Bed does not stay in place.	Locking casters not locked.	Lock casters. Refer to Locking the Casters on page 16.
Pressing function on pendant results in motion other than that intended.	Motor cable connections to junction box incorrect.	Verify connections. Refer to Assembling the Bed on page 22.

NOTES

LIMITED WARRANTY

PLEASE NOTE: THE WARRANTY BELOW HAS BEEN DRAFTED TO COMPLY WITH FEDERAL LAW APPLICABLE TO PRODUCTS MANUFACTURED AFTER JULY 4, 1975.

This warranty is extended only to the original purchaser who purchases this product when new and unused from Invacare or a dealer. This warranty is not extended to any other person or entity and is not transferable or assignable to any subsequent purchaser or owner. Coverage under this warranty will end upon any such subsequent sale or other transfer of title to any other person.

This warranty gives you specific legal rights and you may also have other legal rights which vary from state to state.

Invacare warrants the mechanical and electrical components of this product when purchased new and unused to be free from defects in materials and workmanship for a period of three years from date of purchase from Invacare or a dealer, with a copy of the seller's invoice required for coverage under this warranty. Invacare warrants all welds of this product when purchased new and unused for a period of five years from date of purchase from Invacare or a dealer, with a copy of the seller's invoice required for coverage under this warranty. If within such warranty periods any such product shall be proven to be defective, such product shall be repaired or replaced, at Invacare's option. This warranty does not include any labor or shipping charges incurred in replacement part installation or repair of any such product. Invacare's sole obligation and your exclusive remedy under this warranty shall be limited to such repair and/or replacement.

For warranty service, please contact the dealer from whom you purchased your Invacare product. In the event you do not receive satisfactory warranty service, please write directly to Invacare at the address on the back cover, provide dealer's name, address, and the date of purchase, indicate nature of the defect and, if the product is serialized, indicate the serial number. Do not return products to our factory without our prior consent.

LIMITATIONS AND EXCLUSIONS: THE FOREGOING WARRANTY SHALL NOT APPLY TO SERIAL NUMBERED PRODUCTS IF THE SERIAL NUMBER HAS BEEN REMOVED OR DEFACED, PRODUCTS SUBJECTED TO NEGLIGENCE, ACCIDENT, IMPROPER OPERATION, MAINTENANCE OR STORAGE, PRODUCTS MODIFIED WITHOUT INVACARE'S EXPRESS WRITTEN CONSENT (INCLUDING, BUT NOT LIMITED TO, MODIFICATION THROUGH THE USE OF UNAUTHORIZED PARTS OR ATTACHMENTS; PRODUCTS DAMAGED BY REASON OF REPAIRS MADE TO ANY COMPONENT WITHOUT THE SPECIFIC CONSENT OF INVACARE, OR TO A PRODUCT DAMAGED BY CIRCUMSTANCES BEYOND INVACARE'S CONTROL, AND SUCH EVALUATION WILL BE SOLELY DETERMINED BY INVACARE. THE WARRANTY SHALL NOT APPLY TO NORMAL WEAR AND TEAR OR FAILURE TO ADHERE TO THE PRODUCT INSTRUCTIONS.

THE FOREGOING EXPRESS WARRANTY IS EXCLUSIVE AND IN LIEU OF ANY OTHER WARRANTIES WHATSOEVER, WHETHER EXPRESS OR IMPLIED, INCLUDING THE IMPLIED WARRANTIES OF MERCHANTABILITY AND FITNESS FOR A PARTICULAR PURPOSE, AND THE SOLE REMEDY FOR VIOLATIONS OF ANY WARRANTY WHATSOEVER, SHALL BE LIMITED TO REPAIR OR REPLACEMENT OF THE DEFECTIVE PRODUCT PURSUANT TO THE TERMS CONTAINED HEREIN. THE APPLICATION OF ANY IMPLIED WARRANTY WHATSOEVER SHALL NOT EXTEND BEYOND THE DURATION OF THE EXPRESS WARRANTY PROVIDED HEREIN. INVACARE SHALL NOT BE LIABLE FOR ANY CONSEQUENTIAL OR INCIDENTAL DAMAGES WHATSOEVER.

SOME STATES DO NOT ALLOW THE EXCLUSION OR LIMITATION OF INCIDENTAL OR CONSEQUENTIAL DAMAGE, OR LIMITATION OF HOW LONG AN IMPLIED WARRANTY LASTS, SO THE ABOVE EXCLUSION AND LIMITATION MAY NOT BE APPLICABLE.

THIS WARRANTY SHALL BE EXTENDED TO COMPLY WITH STATE/PROVINCIAL LAWS AND REQUIREMENTS.



Yes, you can.®

Invacare Corporation

www.invacare.com

USA
One Invacare Way
Elyria, Ohio USA
44036-2125
800-333-6900

Canada
570 Matheson Blvd E Unit 8
Mississauga Ontario
L4Z 4G4 Canada
800-668-5324

Invacare, the Medallion Design, and Yes,
you can. are registered trademarks of
Invacare Corporation.

© 2006 Invacare Corporation

Part No 1143215
Rev A - 10/12/06

**Product Distributed
by Invacare**